

ZANUSSI

TUMBLE DRYER TCS 584 EW

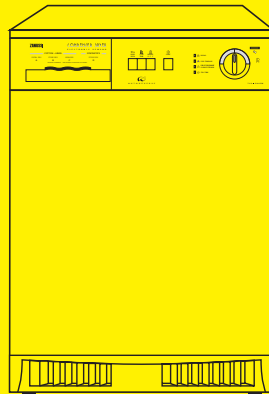



Important Safety Information

It is most important that this instruction book should be retained with the appliance for future reference. Should the appliance be sold or transferred to another owner, or should you move house and leave the appliance, always ensure that the book is supplied with the appliance in order that the new owner can get to know the functioning of the appliance and the relevant warnings.

These warnings have been provided in the interest of safety. You **MUST** read them carefully before installing or using the appliance.

Installation

- This appliance is heavy. Care should be taken when moving it.
- It is dangerous to alter the specifications or attempt to modify this product in any way.
- Any electrical work required to install this appliance should be carried out by a qualified electrician or competent person.
- Care must be taken to ensure that the appliance does not stand on the electrical supply cable.
- If the machine is situated on a carpeted floor, please adjust the feet in order to allow air to circulate freely.
- If the tumble dryer is placed on top of a washing machine, it is compulsory to use the stacking kit (optional accessory).

Child Safety

- This appliance is designed to be operated by adults. Children should not be allowed to tamper with the controls or play with the product.
- Pets and children have been known to climb into tumble dryers. Please check your drum before use.
- Keep all packaging well away for children.

Use

- Do not overload the appliance (see programme chart).
- Clothes which are dripping wet should not be placed in the dryer.
- As some bulky items such as duvets and eiderdowns should be dried in large commercial machines because of their bulk, check with the manufacturer of the item if it is suitable for drying in a domestic machine, even if the dry weight of the item is within the limit advised.
- Do not dry canvas shoes or sports shoes, as they could get stuck between the door and the drum, thus blocking this latter.
- Please make sure that no gas lighters have accidentally been left in pockets of garments to be loaded into appliance.
- **Danger of explosion:** Never tumble dry items that have been in contact with inflammable solvents (petrol, methylated spirits, dry cleaning fluid and the like). As these substance are volatile, they could cause an explosion. Tumble dry only items washed with water.
- In order to avoid danger of fires caused by excessive drying, do not use appliance to dry the following items:
 - Cushions, quilts and the like (these items accumulate heat).
 - Items containing rubber foam or materials similar to rubber foam.
 - Leave the door slightly ajar when the appliance is not being used. This will allow the seal to be preserved.
 - Clean fluff filter after using tumble dryer. To prevent fire risks, do not use the appliance if the fluff filter is damaged or without filter.
- Under no circumstances should you attempt to repair the machine yourself. Repairs carried out by inexperienced persons may cause injury or serious malfunctioning. Contact your local Zanussi Service Centre. Always insist on genuine Zanussi spare parts.

Contents

For the User

| | |
|---|----|
| Important Safety Information | 2 |
| ■ Installation | 2 |
| ■ Child Safety | 2 |
| ■ Use | 2 |
| Your New Tumble Dryer | 4 |
| Description of the Appliance | 4 |
| The Control Panel | 5 |
| ■ Water reservoir | 5 |
| ■ Buttons | 5 |
| ■ Control lights | 5 |
| ■ Programme selector dial/ON-OFF switch | 6 |
| ■ Mains-on light | 6 |
| ■ Electronic Controlled Programmes | 6 |
| ■ Timed Programmes | 6 |
| Programme Chart | 7 |
| Operating Sequence | 8 |
| ■ Load the laundry | 8 |
| ■ Select the drying time or programme | 8 |
| ■ Select the required options | 8 |
| ■ Start the machine | 8 |
| ■ When drying is completed | 8 |
| Hints & Tips on Drying | 9 |
| Maintenance and Cleaning | 10 |
| ■ External cleaning | 10 |
| ■ Cleaning fluff filter | 10 |
| ■ Cleaning the condenser unit | 10 |
| ■ Emptying the water reservoir | 10 |
| Something Not Working | 11 |
| Service and Spare Parts | 11 |
| Customer Care | 11 |
| Guarantee Conditions | 12 |

For the Installer

| | |
|-------------------------------------|----|
| Installation Instructions | 13 |
| Technical Specifications | 13 |
| ■ Positioning | 14 |
| ■ Stacking kit (optional accessory) | 14 |
| ■ Door reversal | 14 |
| ■ Electrical connection | 15 |

Guide to use the Instruction Book

The following symbols will be found in the text to guide you throughout the instructions:



Safety instructions



Hints and tips



Environmental information

i Your New Tumble Dryer

This tumble dryer will give your wash that soft, relaxed feel whatever the weather.

Extremely high quality standards both during development and manufacturing guarantee a long service life for your appliance.

Maximum economy in the operation of your dryer is achieved through very frugal electricity consumption and short drying times.

Energy saving tips

To save energy we recommend that you follow these hints:

- Try to load the maximum capacity of the machine as small loads are **uneconomical**.
- Always load well spun laundry. The higher the spin speed, the lower the electricity consumption and the shorter the drying times.
- Do not over-dry laundry, this avoids creasing and saves energy.
- Clean the filter regularly to avoid excessive drying times and high electricity consumption.
- Ventilate the room well. The room temperature should not exceed +35°C during drying.



In the interest of the environment

- Materials marked with the symbol  are recyclable.
- Check with your local Council or Environmental Health Office to see if there are facilities in your area for re-cycling this appliance.
- When the appliance is to be scrapped, cut off the power supply cable and make the door closing device unusable to prevent young children from being trapped inside.
- Help to keep your country tidy - use authorised disposal sites for your old appliance.

How do we help to protect the environment? We use recycled paper!

Description of the Appliance

- 1 Worktop
- 2 Door Open Button
- 3 «Low Temperature» Button
- 4 «Buzzer off» Button
- 5 «Start» Button
- 6 Control lights
- 7 Programme Selector Dial-ON/OFF switch
- 8 Mains-On Light
- 9 Water reservoir
- 10 Fluff Filter
- 11 Door Catch
- 12 Rating Plate
- 13 Ventilation Grille
- 14 Condenser Unit
- 15 Adjustable Feet

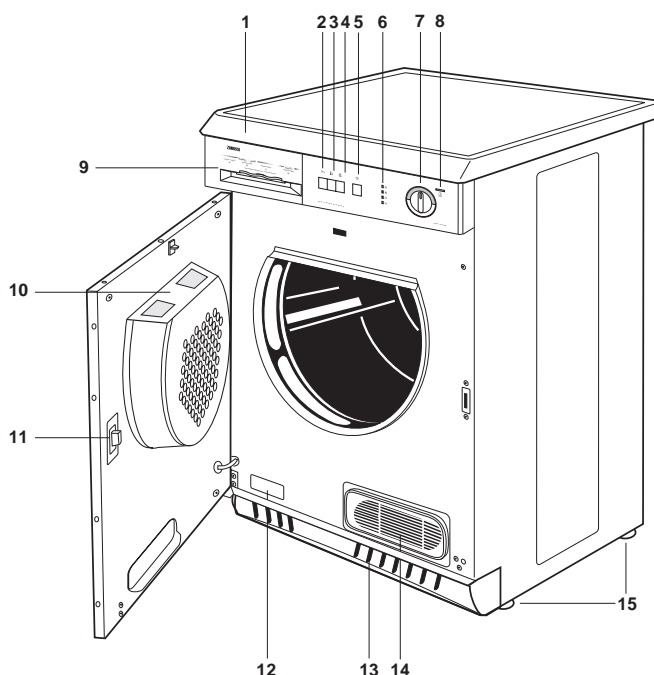

The Control Panel

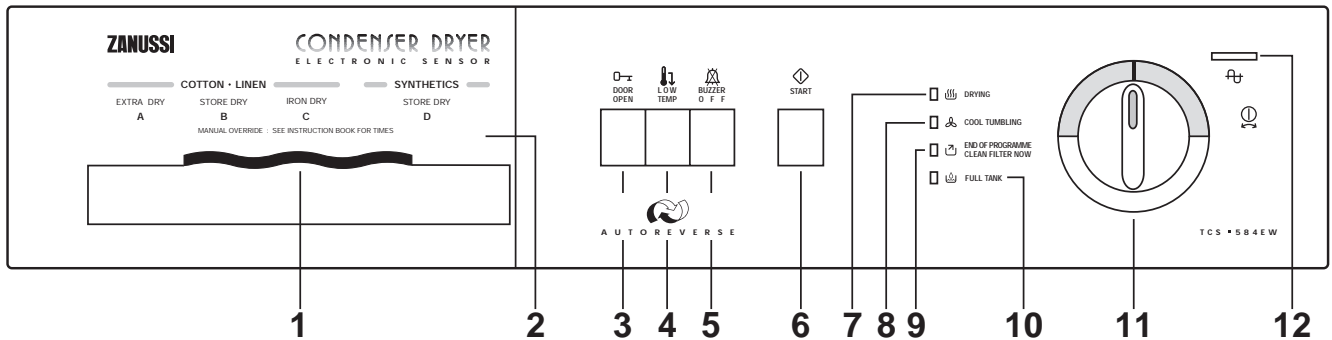

1 Water Reservoir

When the tumble dryer is being used, the condensed water is collected in a special container. To empty the reservoir, please refer to “Maintenance” chapter.

2 Programme Chart

This will help you to select the correct time or programme for drying.

3 Door open button

Depress this button to open the door. Should the door be opened while appliance is working, the tumble dryer will stop functioning. Depress **START** button to resume drying after closing the door.

4 Low Temperature Button

Press this button to reduce the temperature when **drying synthetics with a timed programme.**

5 Buzzer OFF button

During the anti-crease phase, the buzzer will sound intermittently. Depress this button to switch off this function.

Important: When the water reservoir is full, the buzzer will sound for 1 minute, **even** if you have depressed the button .

6 Start button

Press this button to start the selected drying programme.

If the door is opened during drying programme, this button has to be depressed again after closing the door to re-start the programme.

This button must be depressed also after a power failure and after having re-inserted the water reservoir, if it has been emptied during the drying programme.

7 “Drying” Light

This light indicates that the machine is performing the drying phase.

8 “Cool Tumbling” light

This light will illuminate when the cooling phase is in operation. This starts 9 minutes before the end of drying to prevent any creasing or crumpling of fabrics.

9 “End of programme & Clean Filter” Light

This light flashes at the end of the programme (after the cooling phase) and continues to flash during the anti-crease phase to remind you that filter needs cleaning and water reservoir must be emptied. It goes out when you open the door or turn the programme selector dial to “0”.

10 “Full Tank” Light

This light flashes when the water reservoir is full and when drying is completed.

11 Programme Selector Dial/ ON-OFF switch

To set the machine to the selected programme or time, turn the dial until the letter or the time you want coincides exactly with the pointer.

12 Mains-On Light

This lights up by selecting the drying programme and goes out when the programme selector dial is turned to “0” or by opening the door.

Electronic Controlled Programmes

These operate by means of dampness sensors.

All you have to do is to set the selector dial for the programme required A, B, C or D and the laundry will be dried to the selected degree of dryness.

The following are the degrees of final drying which can be obtained with electronic control:

- **“A” Extra Dry** (Cotton & Linen)
Ideal for bathrobes, bath towels etc.
- **“B” Store Dry** (Cotton & Linen)
Suitable for items which you want to put away without ironing, for example towels and non-iron fabrics.
- **“C” Iron Dry** (Cotton & Linen)
Suitable for items which need ironing.
- **“D” Store Dry** (Synthetics)
Suitable for delicate articles which do not need ironing.

Timed Programmes

For a personalized drying or additional drying of single items.

The selector dial incorporates a drying cycle up to 90 minutes.

The selected time can be extended when the original programme is completed, by resetting the dial for a further period of drying.

See chart on page 7.

Remember that during the last 9 minutes of programme, the heat is cut off in order to carry out a fabric cooling phase, which prevents any creasing or crumpling of the fabrics.

When drying synthetics, select low temperature by pressing the LOW TEMP.  button.

Programme Chart

Electronic Controlled Programmes

| Type of laundry: | Degree of drying required | Amount of laundry in kg | Selector dial setting |
|------------------|---------------------------|-------------------------|-----------------------|
| Cotton & linen | Extra dry | 5 | A |
| | Store dry | 5 | B(*) |
| | Iron dry | 5 | C(*) |
| Synthetics | Store dry | 2.5 | D(*) |

(*) According to CEI 1121 standards.

Timed Programmes

Cotton and linen

| Type of laundry: | Degree of drying required | Amount of laundry in kg | Drying time in minutes for laundry spun at | | |
|--|---|-------------------------|--|----------|----------|
| | | | 800 rpm | 1000 rpm | 1200 rpm |
| Cotton Towelling Shirts Sheets Hand towels Tablecloths Table napkins | Store dry (wardrobe dry) | 3.5 | 90 | 75 | 60 |
| | | 2 | 75 | 60 | 45 |
| | Iron dry (not completely dry; suitable for ironing) | 3.5 | 75 | 60 | 45 |
| | | 2 | 60 | 45 | 30 |

Synthetics: depress LOW TEMP. button 

| Type of laundry: | Degree of drying required | Amount of laundry in kg | Drying time in minutes for laundry spun at a minimum speed of 650 rpm |
|---|---------------------------|-------------------------|---|
| Synthetics or mixed fabrics which do not require ironing. | Store dry | 2.5 | 45 |
| | | 1 | 30 |
| | | 0.5 | 20 |

Operating Sequence

Before using your tumble dryer for the first time, we recommend to place a few damp cloths inside the appliance and dry for approximately 20 minutes. There may be dust inside a brand new tumble dryer.

1. Load the laundry

Open the door by pressing the relevant button. Load the items one at a time, shaking them out loosely and close the door. Please check the laundry does not get caught between the door and filter.

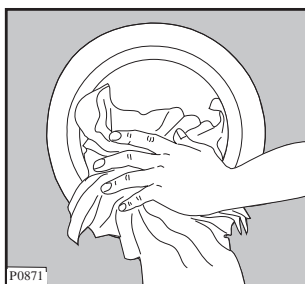

2. Select the drying time or the drying programme

Turn the selector dial to the desired programme or time, the mains-on light illuminates.

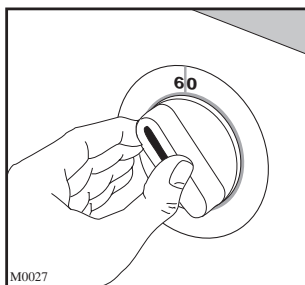

3. Select the required options

Depress Buzzer Off and/or Low Temp. Button, if you have to dry synthetics with a timed programme.

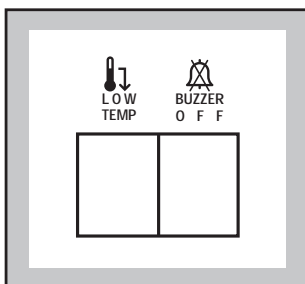



4. Start the machine

Depress START button, the machine starts operating.

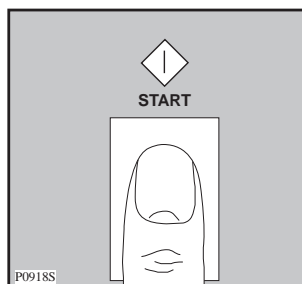
To change a programme already in progress, turn the selector dial to “0”, select the new programme and then depress START button.





5. When drying is completed

The machine stops automatically. The control lights  and  are flashing.

Release the button(s).

Turn the selector dial to “0”, the mains-on light and control lights go out.

Anticrease phase

If you do not remove the laundry at the end of the programme, the machine will automatically carry out an “anticrease” phase for approx 30 mins. During this period the drum will rotate at regular intervals to avoid creasing and the buzzer will sound for 1 second every 10 seconds, unless you have depressed the BUZZER OFF button. The lights  and  will flash alternatively.

Empty the water reservoir and clean the filter after every drying programme.



A clean filter ensures correct functioning of the appliance.



Hints & Tips on Drying

Before placing articles of laundry in your tumble dryer, check the care labels to ensure they are recommended for tumble drying.

Care Labels you may find on your laundry

-  normal drying (high temperature)
-  delicate drying (low temperature)
-  do not tumble dry



Do not overload the appliance.

Here is a list of the approximate weight of some common laundry items.

| | |
|------------------|----------------|
| Sheet | 700 to 1000 g |
| Pillowcase | 100 to 200 g |
| Tablecloth | 400 to 500 g |
| Table Napkin | 50 to 100 g |
| Kitchen Towel | 70 to 120 g |
| Linen Hand Towel | 100 to 150 g |
| Hand Towel | 150 to 250 g |
| Bath Towel | 700 to 1000 g |
| Bathrobe | 1000 to 1500 g |
| Shirt | 200 to 300 g |
| Apron | 150 to 200 g |

- Always load well spun laundry. The higher the spin speed the lower the electricity consumption and the shorter the drying time.
- DO NOT load dripping wet laundry into the dryer. Roll the article in a towel or spin to remove excess water.
- Close poppers and zips and fasten any buttons.
- Sort the laundry. Separate synthetics from cotton/linens, and dry separately.
- Remove the laundry immediately after the programme has finished.
- Use a fabric conditioning sheet to reduce static. We recommend the sheet is pinned to an article of laundry (using a safety pin).
- Mix the load i.e. large and small articles.
- When drying large items such as sheets, we recommend you periodically stop the dryer to redistribute the load.

DO NOT use the tumble dryer to dry the following:

- Articles contaminated with inflammable substances e.g. petrol, cleaning solvents, cooking oil, fats or hair lacquer.
- Woollen and synthetic/wool mixtures unless the item is labelled as suitable for tumble drying.
- Very delicate articles such as silk.
- Very large and bulky items such as duvets or sleeping bags.

Maintenance and Cleaning

You must **disconnect** the appliance from the electricity supply, before you can carry out any cleaning or maintenance work.

External cleaning

Use only soap and water and then dry thoroughly. From time to time, apply a little wax furniture cream with a soft cloth.

Important: do not use methylated spirit, diluents or similar products.

Cleaning the filter

The tumble dryer cannot operate efficiently with a clogged filter. The filter collects all the fluff which forms during drying and it is therefore essential to remove and clean this filter after each drying programme.

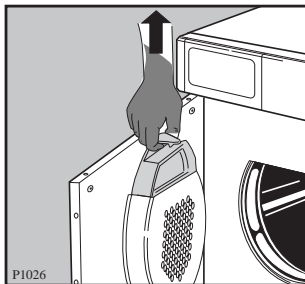

You should not be alarmed by the amount of fluff which collects on the filter; this is due to normal wearing of the fabrics dried and not to incorrect operation of your machine. Rubbing of the fibres during normal wear and washing forms fluff. If laundry is dried on a line, this fluff simply flies away, whereas inside the tumble dryer it collects together and swells considerably as a result of the drying action.

Cleaning the condenser unit

Clean the air condenser periodically, 3 or 4 times a year depending on how frequently the dryer is used. Pull out the condenser, holding it at the top, and remove all fluff. Clean it with a brush and rinse it under the shower if necessary.

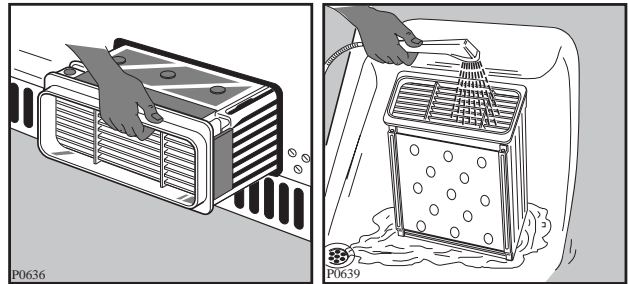

Also clean the outside, removing all fluff. Clean the rubber seal round the porthole door and the seal of the condenser in the inner door with a damp cloth.

Emptying the water reservoir

Water extracted from the laundry condenses inside the machine and is collected in a reservoir. The reservoir must be emptied after each drying cycle to ensure efficient operation when the machine is next used.

If this is not done a safety device trips: pilot light  on the control panel comes on and the programme stops, leaving the laundry damp.

The reservoir can be emptied even in the middle of a programme. After inserting the reservoir depress START button to re-start the programme.

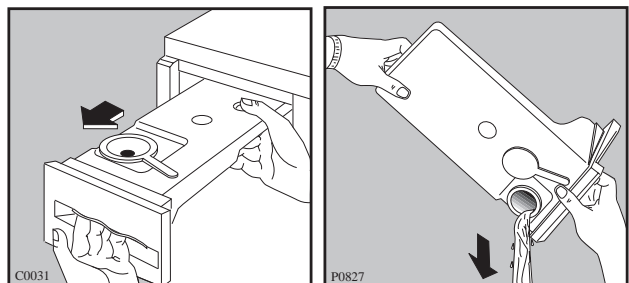

The reservoir must be re-inserted correctly.

Handy tip: The condensed water may be used in a steam iron or to top up a battery, etc. In this case it must be filtered (e.g. through a coffee filter).

Something Not Working

Certain problems are due to lack of simple maintenance or oversights, which can be solved easily without calling out an engineer. Before contacting your local Service Centre, please carry out the checks listed below.

IMPORTANT: if you call out an engineer to a fault listed below, or to repair a fault caused by incorrect use or installation, a charge will be made even if the appliance is under guarantee.

| Symptom | Possible causes |
|--|--|
| The tumble dryer does not start | <ul style="list-style-type: none"> ■ The door has not been closed. ■ The plug is not properly inserted in the power socket. ■ There is no current at the socket ■ The main fuse or the fuse in the plug has blown. ■ A drying time or programme has not been selected. ■ The water reservoir is full or not properly inserted (the pilot light  is on). ■ The START button has not been depressed. |
| Drying takes too long or laundry is not dry enough. | <ul style="list-style-type: none"> ■ The laundry has not been spun properly. ■ The filter and/or air condenser are clogged up. ■ The room temperature is too high. ■ The selected time or programme was not suitable for the laundry ■ There is too much laundry inside the appliance. ■ The dryer is not correctly installed. |

If after the above checks, there is still a fault, call your local Zanussi Service Force Centre.

Service & Spare Parts

If you require an engineer or wish to purchase spare parts contact your local Zanussi Service Force Centre by telephoning:

0870 5 929929

Your telephone call will be routed to the Service Centre covering your post code area. Further information can be found in the accompanying customer care booklet and also in your telephone directory under "Z". When you call the Service Force Centre please make sure you give the model and serial number of the appliance.

This information can be found on the rating plate (see picture) or on the guarantee card.

In-guarantee customers should ensure that the above checks have been made as the engineer will make a charge if the fault is not a mechanical or electrical breakdown. Please note that proof of purchase is required for any in-guarantee service calls.

Customer Care

For general enquiries concerning your Zanussi appliance or for further information on Zanussi products, please contact our Customer Care Department by letter or telephone as follows:

Customer Care Department
Zanussi
55-77 High Street
Slough
Berkshire
SL1 1DZ
Tel 08705 727727

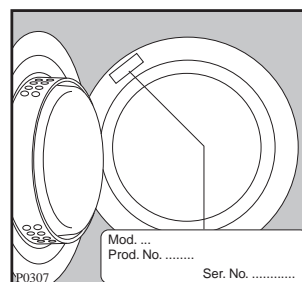

Peace of Mind for Twelve Months

Standard guarantee conditions

We, Zanussi Limited undertake that if, within 12 months of the date of the purchase, this Zanussi appliance or any part thereof is proved to be defective by reason only of faulty workmanship or materials, we will, at our option, repair or replace the same **FREE OF ANY CHARGE** for labour, materials or carriage on condition that:

- The appliance has been correctly installed and used only on the electricity supply stated on the rating plate.
- The appliance has been used for normal domestic purposes only, and in accordance with the manufacturer's instructions.
- The appliance has not been serviced, maintained, repaired, taken apart or tampered with, by any person not authorised by us.

All service work under this guarantee must be undertaken by a Zanussi Service Force Centre.

Any appliance or defective part replaced shall become the Company's property.

This guarantee is in addition to your statutory and other legal rights.

Home visits are made between **8.30am** and **5.30pm** Monday to Friday. Visits may be available outside these hours in which case a **premium** will be charged.

Exclusions

This guarantee does not cover:

- Damage or calls resulting from transportation, improper use or neglect, the replacement of any light bulbs or removable parts of glass or plastic.
- Costs incurred for calls to put right an appliance which is improperly installed or calls to appliances outside the United Kingdom.
- Appliances found to be in use within a commercial environment, plus those which are subject to rental agreements.
- Products of Zanussi manufacture which are NOT marketed by Zanussi Ltd.

European guarantee



If you should move to another country within Europe then your guarantee moves with you to your new home subject to the following qualifications:

- The guarantee starts from the date you first purchased your product.
- The guarantee is for the same period and to the same extent for labour and parts as exists in the new country of use for this brand or range of products.
- The guarantee relates to you and cannot be transferred to another user.
- Your new home is within the European Community (EC) or European Free Trade Area.
- The product is installed and used in accordance with our instructions and is only used domestically, i.e. a normal household.
- The product is installed taking into account regulations in your new country.

Before you move please contact your nearest Customer Care Centre, listed below, to give them details of your new home. They will then ensure that the local Service Organisation is aware of your move and able to look after you and your appliances.

| | | |
|---------|-----------|---------------------|
| France | Senlis | +33 (0)344 62 29 99 |
| Germany | Nurnberg | +49 (0)911 323 2600 |
| Italy | Pordenone | +39 (0)1678 47053 |
| Sweden | Stockholm | +46 (0)8 738 79 50 |
| UK | Newbury | +44 (0)1635 521313 |

Installation Instructions

-  It is dangerous to alter the specifications or attempt to modify this product in any way.
-  Care must be taken to ensure that the appliance does not stand on the electrical supply cable.
-  Any electrical work required to install this appliance should be carried out by a qualified electrician or competent person.

Technical Specifications

| | | |
|--|--|---|
| DIMENSIONS | Height Width Depth | 85 cm (33.5") 60 cm (23.6") 60 cm (23.6") |
| POWER SUPPLY VOLTAGE TOTAL POWER ABSORBED | | 230-240 V/50 Hz 2650 W (13A) |
| MAXIMUM RECOMMENDED LOAD | Cotton, linen Synthetics, delicates | 5 kg (11 lbs) 2.5 kg (5 lbs) |
| DRUM VOLUME | | 108 l |

- CE** This appliance complies with the following E.E.C. Directives:
- 73/23 EEC of 19.2.73 (Low Voltage Directive) and subsequent modifications;
 - 89/336 EEC of 3.5.89 (Electromagnetic Compatibility Directive) and subsequent modifications.

Positioning

It is recommended that, for your convenience, the dryer is positioned close to your washing machine.

The tumble dryer must be installed in a clean place, where dirt does not build up.

Air must be able to circulate freely all round the appliance. Do not obstruct the front ventilation grille or the air intake grilles in the back of the machine.

To keep vibration and noise to a minimum when the dryer is in use, it should be placed on a firm, level surface.

Once in its permanent operating position, check that the dryer is absolutely level with the aid of a spirit level. If it is not, raise or lower the four adjustable feet until it is.

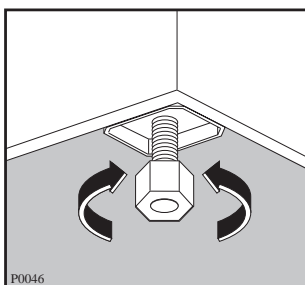

The feet must never be removed.

Do not restrict the floor clearance through deep-pile carpets, strips of wood or similar. This might cause heat build-up which would interfere with the operation of the appliance.

Important

When operating the tumble dryer, the room temperature must not exceed 35°C, as it may affect the performance of the appliance.

Stacking kit

A special stacking kit is available through your dealer, to enable the mounting of the dryer on top of your washing machine.

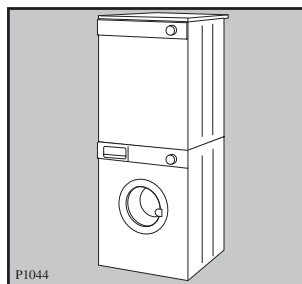

Door reversal

To make it easier to load or unload the laundry the door can be reversed.

This operation must be carried out by qualified personnel.

Please contact the nearest Zanussi Service Centre.

Electrical connection

Any electrical work required to install this appliance should be carried out by a qualified electrician or competent person.

WARNING: THIS APPLIANCE MUST BE EARTHED.



The manufacturer declines any liability should this safety measure not be observed.

Before switching on, make sure the electricity supply voltage is the same as that indicated on the appliance's rating plate. (See picture).

The appliance is supplied with a 13amp plug fitted. In the event of having to change the fuse in the plug supplied, a 13amp ASTA approved (BS1363A) fuse must be used.

Should the plug need to be replaced for any reason, proceed as described below.

The wires in the mains lead are coloured in accordance with the following code:

Green and Yellow - Earth

Blue - Neutral

Brown - Live

The wire coloured green and yellow must be connected to the terminal marked with the letter «E» or by the earth symbol \perp or coloured green and yellow.

The wire coloured blue must be connected to the terminal «N» or coloured black.

The wire coloured brown must be connected to the terminal marked «L» or coloured red.

Upon completion there must be no cut, or stray strands of wire present and the cord clamp must be secure over the outer sheath.

WARNING:



A cut off plug inserted into a 13 amp socket is a serious safety (shock) hazard.

Ensure that the cut off plug is disposed of safely.

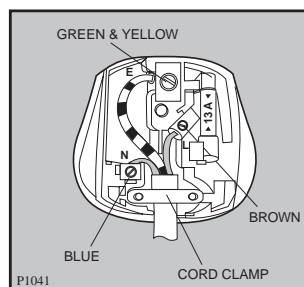
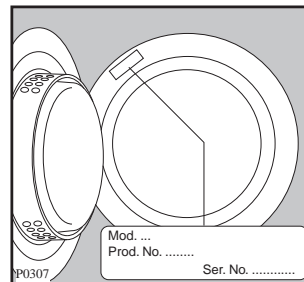

Permanent connection

In the case of permanent connection it is necessary that you install a double pole switch between the appliance and the electricity supply (mains), with a minimum gap of 3mm between the switch contacts and of a type suitable for the required load in compliance with the current electrical regulations.

The switch must not break the yellow and green earth cable at any point.

